

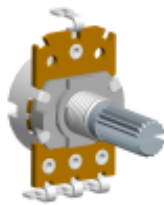

16mm Metal Shaft Rotary Potentiometer

16KT9



Part Number

16KT9 – B 10K, L- 20 KC

Taper

Shaft Length

Resistance value

Shaft Type

Dimensions

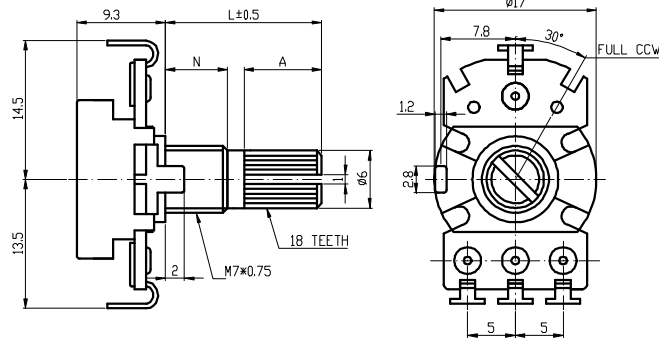

CIRCUIT

Standard 标准型

No tap 无抽头

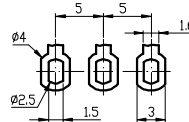
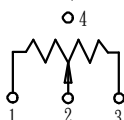
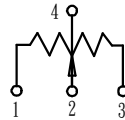

Shaft Type

KC Type

KC/CI Type

F Type

RE Type

R Type

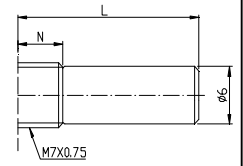
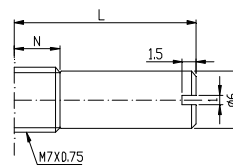
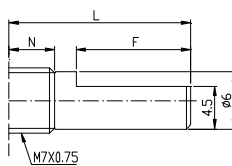
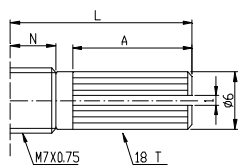
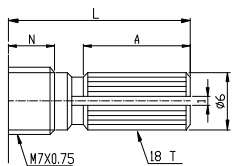

		N=6.5mm								
Shaft Type	L	10	15	17	20	25	30	35	40	
KC	A	2.2	6	8	10	12	12	12	12	
	M	0.5	1	1	2	2	4	4	4	
KC/CI	A	1.5	6.5	8.5	11.5	16.5	19			
F	F	2.5	7	7	12	12	12	12	12	
R,RE	L	10	15	17	20	25	30	35	40	

		N=5mm								
Shaft Type	L	10	12	15	17	20	25	30	35	40
KC	A	3.2		6	8	12	12	12	12	12
	M	0.5		1	1	2	2	4	4	4
KC/CI	A	1.5	5	8	10	13				
F	F	4	4	7	7	12	12	12	12	12
R,RE	L	10		15	17	20	25	30	35	40

**16mm Metal Shaft Rotary Potentiometer****General**

Operating temperature	-10 °C ~ +70 °C
Manual soldering	300 °C Max 3sec

Electrical Characteristics

Total resistance	500Ω~2MΩ
Resistance tolerance	±20% (more than 1MΩ ±30%)
Resistance taper	A B C W MN
Sliding noise	Less than 47 mV
Residual resistance	≤ 20 Ω (R>10K) ≤ 10 Ω (R≤10K)
Insulation resistance	More than 100 MΩ at DC 500 V
Rated power(W)	Linear (B) taper : 0.125 W Other taper : 0.06W
Max. Operating voltage	Linear (B) taper : 200 V Other taper : 150 V
Withstand voltage	1 Minute at AC 500 V

Mechanical Characteristics

Total rotational angle	300 °±5 °
Rotational torque	30~200 gf.cm
C.C torque	100~350gf.cm
Rotational stopper strength	8 Kgf.cm Max.
Shaft push-pull strength	7 Kgf. Max.
Rotational life	15,000 Cycles