

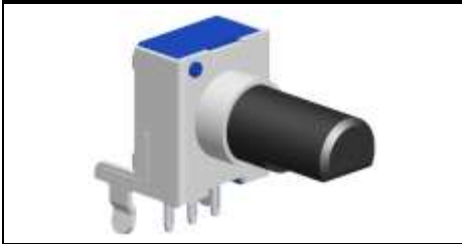

9mm Snap-In Insulated Shaft Potentiometer

R0902N



Part Number

R0902N – B 50K , L- 20 F /H=6.5

Taper

Shaft Length

High

Resistance value

Shaft Type

Dimensions

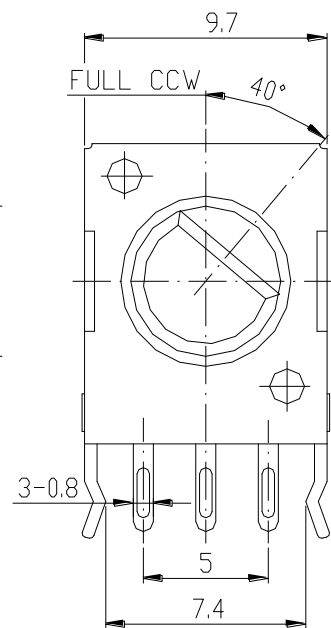
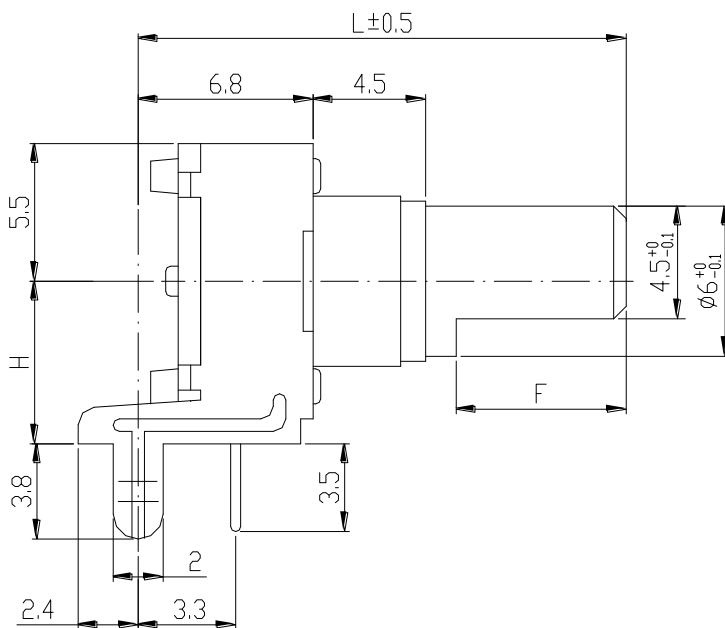

CIRCUIT

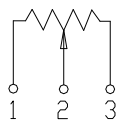

PCB LAYOUT

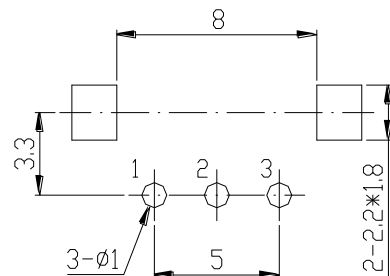

H	6.5	10	12.5
----------	------------	-----------	-------------



9mm Snap-In Insulated Shaft Potentiometer

Shaft Type

KC Type				KS Type				KQ Type			
L	15	20	25	L	15	20	25	L	15	20	25
A	7	7	7	A	7	7	7	A	6	7	7

KT Type					F Type			
L	9	15	20	25	L	15	20	25
A	--	6	7	7	A	6	7	12

**9mm Snap-In Insulated Shaft Potentiometer****General**

Operating temperature	-10 °C ~ +70 °C
Manual soldering	300 °C Max 3sec

Electrical Characteristics

Total resistance	500Ω ~ 500KΩ
Resistance tolerance	±20%
Resistance taper	A B C
Sliding noise	Less than 80 mV
Residual resistance	Term. 1~2 :Less than 20Ω Term. 2~3 :Less than 40Ω
Insulation resistance	More than 100MΩ at DC 250V
Rated power(W)	0.05W
Max. Operating voltage	AC 50V / DC 20V
Withstand voltage	1 Minute at AC 250 V

Mechanical Characteristics

Total rotational angle	280° ± 10°
Rotational torque	30 ~ 150 gf.cm
Rotational stopper strength	3Kgf.cm Min
Shaft push-pull strength	4Kgf. Max
Rotational life	15,000 Cycles.