



16mm Snap-in Insulated Shaft Potentiometers

R1643G



Part Number

R1643G- B 50K, L - 20 F

↓ Taper ↓ Resistance Value ↓ Shaft Type

Shaft Length

Dimensions

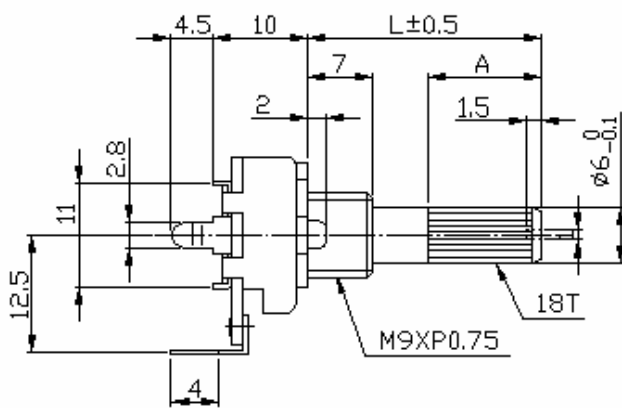

FULL C.C.W POSITION

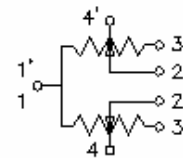
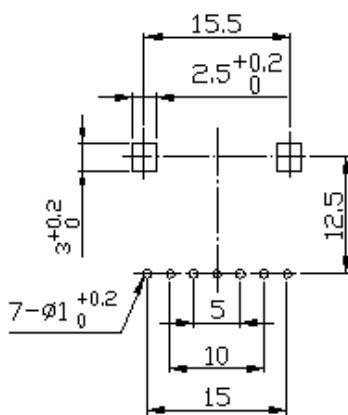
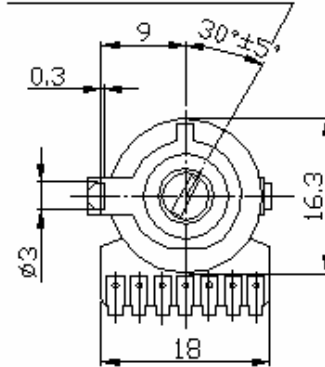



16mm Snap-in Insulated Shaft Potentiometers

Shaft Dimensions

KC TYPE
18TEETH

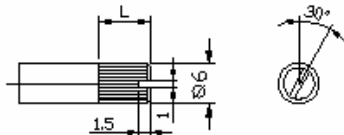

SHAFT SHOWN IN
FULL C.C.W. POSITION

HORIZONTAL WITH BUSHING

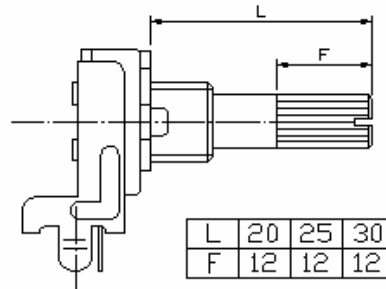

F Type

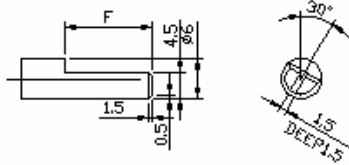

SHAFT SHOWN IN
FULL C.C.W. POSITION

F Type

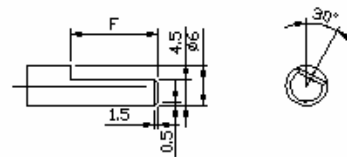

SHAFT SHOWN IN
FULL C.C.W. POSITION

Horizontal with bushing

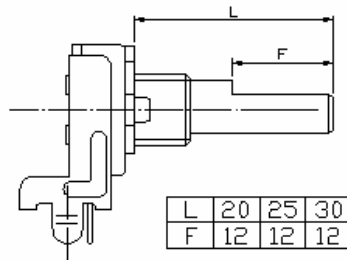

Bushing Dimension

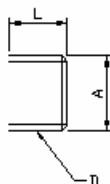

L	A	D	
7	Ø9	M9x0.75	STD

Stopper Dimension

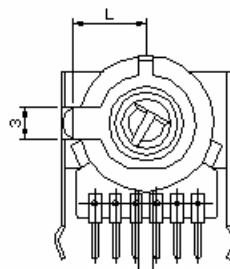

L	
9	STANDARD



16mm Snap-in Insulated Shaft Potentiometers

Electrical Characteristics

Total Resistance	5K ~ 2M Ω				
Total Resistance Tolerance	$\pm 20\%$				
Resistance Taper	A. B. C. D. W. Taper				
Resistance Taper Characteristics	A50%	B50%	C50%	D50%	W50%
	15-25%	40-60%	75-85%	2-15%	45-55%
Rated Power	B Taper: 50V 0.1W; Other Tapers: 50V 0.05W				
Residual Resistance	$R \geq 250K\Omega$ 0.1% $250K\Omega > R > 10K\Omega$ 20 Ω Max. (between Term. 1, 2) $10K\Omega \geq R$ 20 Ω Max. (between Term. 2, 3)				
Gang Error	-40 ~ 0db ≤ 3 db				
Noise	47 mV Max.				
Insulation Resistance	DC250V 100M Ω				
Withstand Voltage	1 minute at AC250V				
Rotational Life	10,000 Cycles				

Mechanical Characteristics

Total Rotational Angle	300° $\pm 5^\circ$
Stopper Strength	6kgf.cm max./3sec.
Rotational Torque	30 ~ 250 gf.cm
Shaft Pull-Push Strength	8kgf.cm max./3 minute.
Shaft Lever Wobble	With bushing 0.7 x L /30 mmp-p max.
Center Click Torque	60 ~ 300 g.cm
Shaft Bending	0.3mm max.
Soldering Heat	300°C, 3s. (Only for Hand-Soldering)
Remark	♣ Insulated shaft of black.