



16mm Metal Shaft Rotary Potentiometer – With Tap

R16GT8



Part Number

R16GT8 - B 50K, L - 20 KC

Taper

Resistance Value

Shaft Type

With Tap

Shaft Length

Dimensions

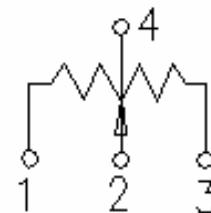
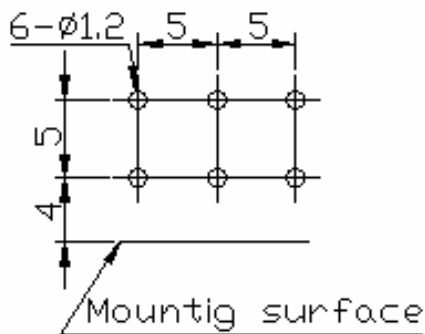
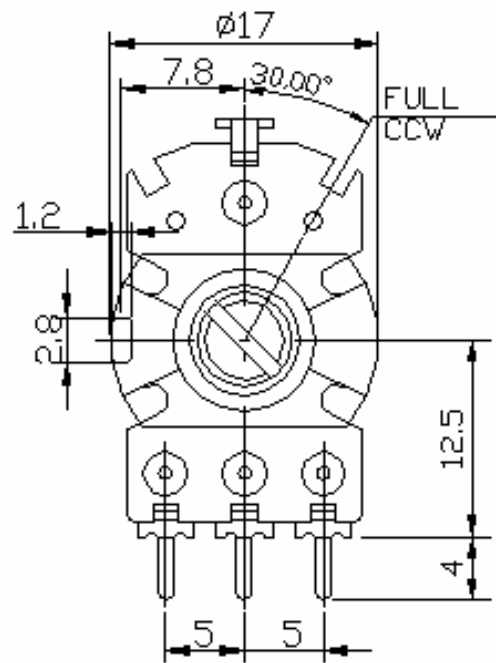
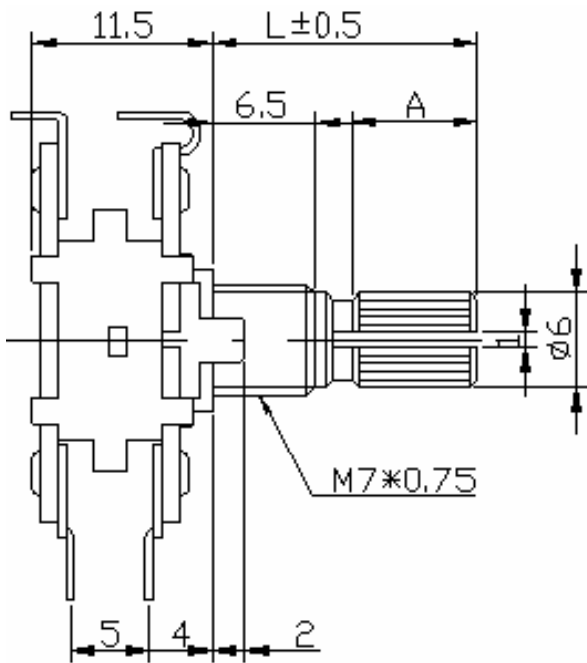



16mm Metal Shaft Rotary Potentiometer – With Tap

Shaft Type

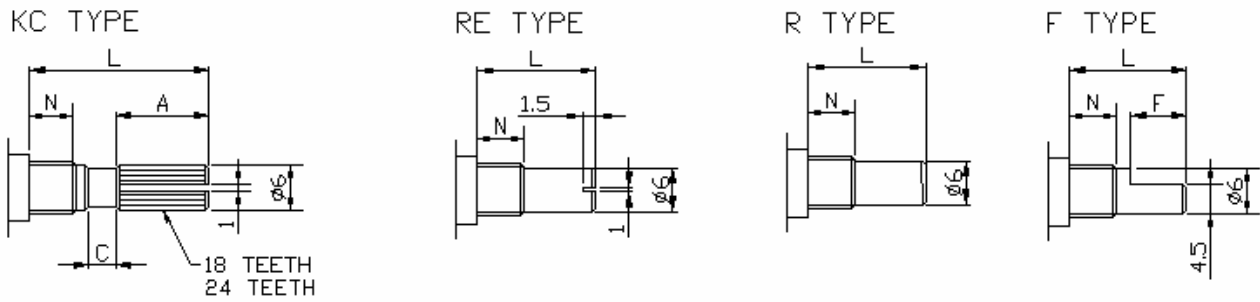

N:6.5m/m

SHAFT-TYPE	L	10	15	20	25	30	35	40
KC	A	2.2	6	10	12	12	12	12
	C	0.5	1	2	2	4	4	4
F	F	2.5	7	12	12	12	12	12
R,RE	L	10	15	20	25	30	35	40

**16mm Metal Shaft Rotary Potentiometer – With Tap****Electrical Characteristics**

Total Resistance	500Ω ~ 2MΩ				
Total Resistance Tolerance	± 20% (More than 1MΩ± 30%)				
Resistance Taper	A. B. C. D. W. Taper				
Resistance Taper Characteristics	A50%	B50%	C50%	D50%	W50%
	15-25%	40-60%	75-85%	2-15%	45-55%
Rated Power	B Taper: 0.2 W; Other Tapers: 0.1 W				
Max. Operating Voltage	B Taper: AC200V; Other Tapers: AC150V				
Residual Resistance	R ≥ 250KΩ 0.1%				
	250KΩ > R > 10KΩ		10Ω Max. (between Term. 1, 2)		
	10KΩ ≥ R		10Ω Max. (between Term. 2, 3)		
Noise	47 mV max.				
Insulation Resistance	DC 500V 100MΩ				
Withstand Voltage	1 minute AC 500V				
Rotational Life	15,000 Cycles				
Switch Life	10,000 Cycles				

Mechanical Characteristics

Total Rotational Angle	300° ± 5°
Rotational Torque	30~200gf.cm
Pull-Push Strength	7 kgf.cm max./3 minute.
Center Click Torque	150~350g.cm
Click Position	Center 11/21/31/41 Detents
Solder Heat Resistance	300°C, 3s (Only For Hand-Soldering)
Remark	Shaft: Cast Iron (Aluminum Zinc)
	Bushing Material: cast iron