

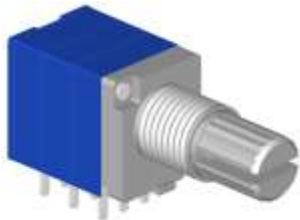

9mm Metal Shaft Rotary Potentiometer

RK0973



Part Number

RK0973- B 50K , L- 20 KC / N=5

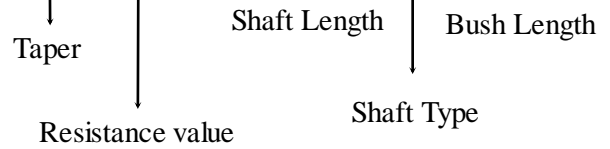

Dimensions

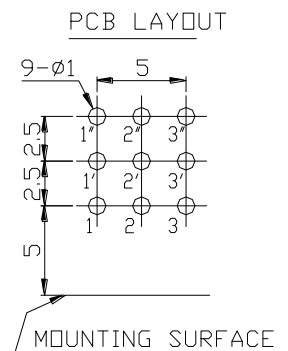
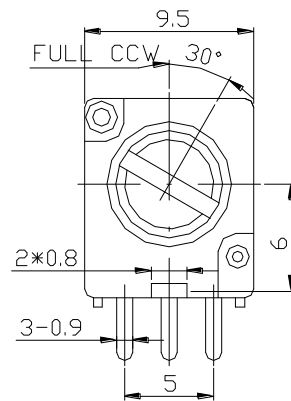
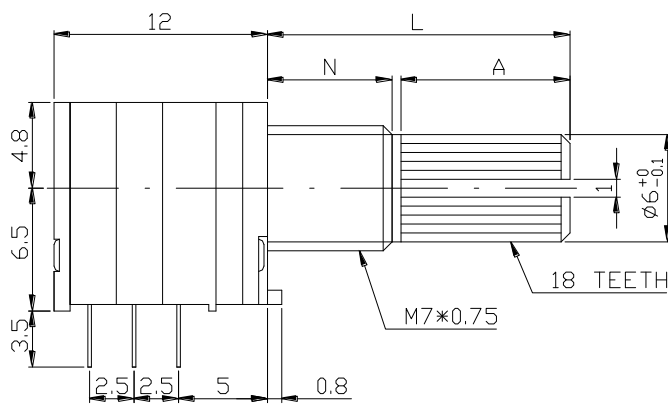

CIRCUIT

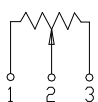

Shaft Type

KC Type

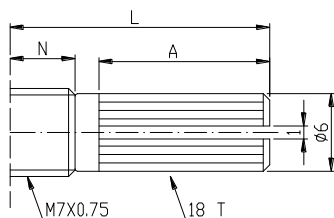

N=5mm				
L	10KC	12.5KC	15KC	20KC
A	4	7	7	12
N=7mm				
L	15KC	20KC	25KC	
A	7	12	12	

F Type

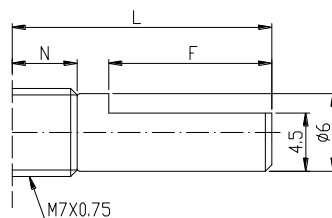

N=5mm		
L	15F	20F
F	7	12
N=7mm		
L	15F	20F
F	7	12

RE Type

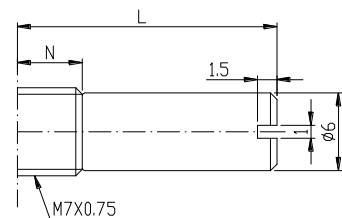

N=5mm		
L	8RE	10RE
N=7mm		
L	15RE	

**9mm Metal Shaft Rotary Potentiometer****General**

Operating temperature	-10 °C ~ +70 °C
Manual soldering	300 °C Max 3sec

Electrical Characteristics

Total resistance	1KΩ ~ 500KΩ
Resistance tolerance	$\pm 20\%$ (More Than 1MΩ $\pm 30\%$)
Resistance taper	A B C W
Sliding noise	Less than 68 mV
Residual resistance	$\leq 20 \Omega$
Insulation resistance	More than 100MΩ at DC 250V
Rated power(W)	0.05W
Max. Operating voltage	50V AC
Withstand voltage	1 Minute at AC 300 V
Gang error	Linear (B) taper : 0 ~ -20dB ≤ 2dB A/C Other tapers : 0 ~ -40dB ≤ 2dB

Mechanical Characteristics

Total rotational angle	300° \pm 5°
Rotational torque	20 ~ 250 gf.cm
Switch action	400 gf.cm
Rotational stopper strength	4Kgf.cm Min
Shaft push-pull strength	10Kgf. Max