



**9mm Metal Shaft Rotary Potentiometer**

**RK0974**



**Part Number**

**RK0974- B 50K , L- 20 KC / N=5**

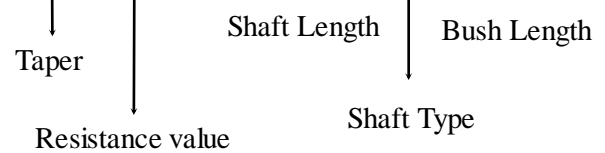

**Dimensions**

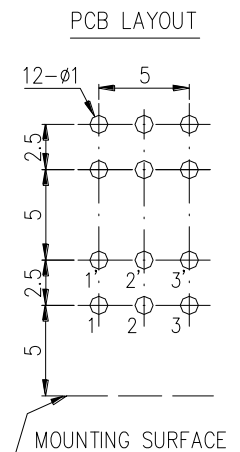
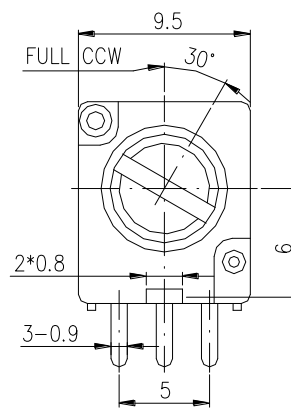
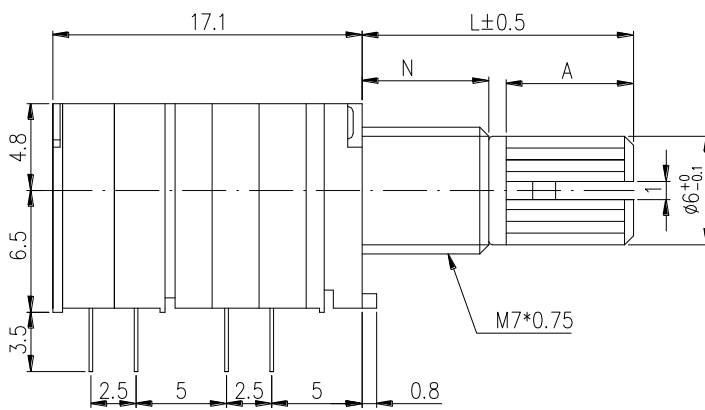

**CIRCUIT**

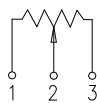

**Shaft Type**

**KC Type**

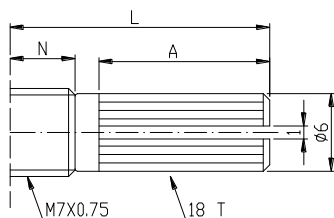

N=5mm				
L	10KC	12.5KC	15KC	20KC
A	4	7	7	12
N=7mm				
L	15KC	20KC	25KC	
A	7	12	12	

**F Type**

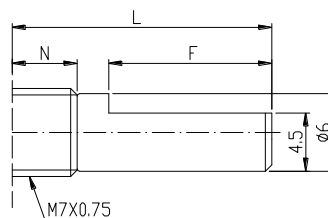

N=5mm		
L	15F	20F
F	7	12
N=7mm		
L	15F	20F
F	7	12

**RE Type**

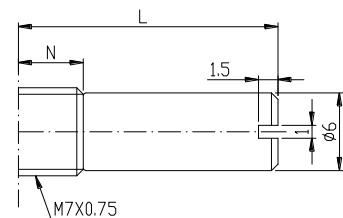

N=5mm		
L	8RE	10RE
N=7mm		
L	15RE	

**9mm Metal Shaft Rotary Potentiometer****General**

<b>Operating temperature</b>	<b>-10 °C ~ +70 °C</b>
<b>Manual soldering</b>	<b>300 °C Max 3sec</b>

**Electrical Characteristics**

<b>Total resistance</b>	<b>1K<math>\Omega</math> ~ 500K<math>\Omega</math></b>
<b>Resistance tolerance</b>	<b><math>\pm 20\%</math> (More Than 1M<math>\Omega</math> <math>\pm 30\%</math>)</b>
<b>Resistance taper</b>	<b>A B C W</b>
<b>Sliding noise</b>	<b>Less than 68 mV</b>
<b>Residual resistance</b>	<b><math>\leq 20 \Omega</math></b>
<b>Insulation resistance</b>	<b>More than 100M<math>\Omega</math> at DC 250V</b>
<b>Rated power(W)</b>	<b>0.05W</b>
<b>Max. Operating voltage</b>	<b>50V AC</b>
<b>Withstand voltage</b>	<b>1 Minute at AC 300 V</b>
<b>Gang error</b>	<b>Linear (B) taper : 0 ~ -20dB <math>\leq 2</math>dB A/C Other tapers : 0 ~ -40dB <math>\leq 2</math>dB</b>

**Mechanical Characteristics**

<b>Total rotational angle</b>	<b>300° <math>\pm</math> 5°</b>
<b>Rotational torque</b>	<b>20 ~ 250 gf.cm</b>
<b>Switch action</b>	<b>400 gf.cm</b>
<b>Rotational stopper strength</b>	<b>4Kgf.cm Min</b>
<b>Shaft push-pull strength</b>	<b>10Kgf. Max</b>