



**12mm Metal Shaft Rotary Potentiometer (4 Ganged) – With Switch**

**RK1224S**



**Part Number**

**RK1224S - B 50K, L - 20 KC**

With Switch      Taper      Resistance Value      Shaft Type  
Shaft Length

**Dimensions**

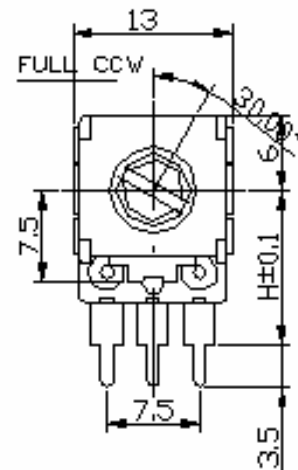
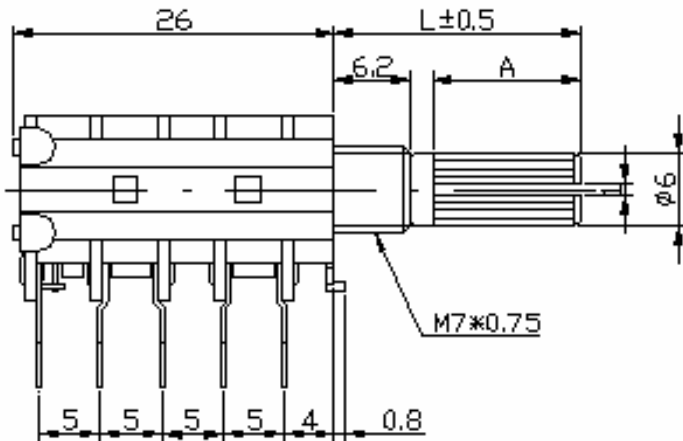

<b>H</b>	<b>10</b>	<b>12.5</b>
----------	-----------	-------------

**P.C.B LAYOUT**

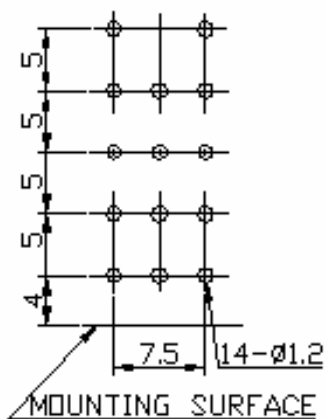

**CIRCUIT**

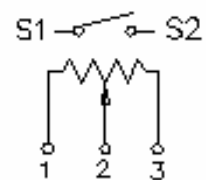



**12mm Metal Shaft Rotary Potentiometer (4 Ganged) – With Switch**

**Shaft Type**

KC TYPE

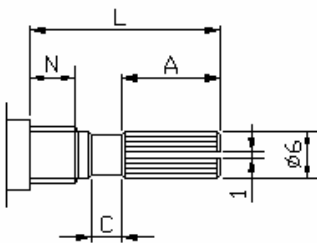

RE TYPE

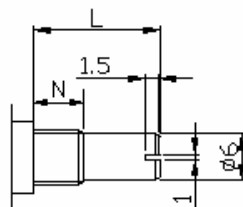

R TYPE

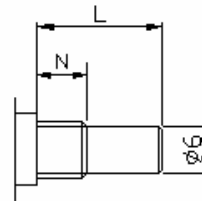

F TYPE

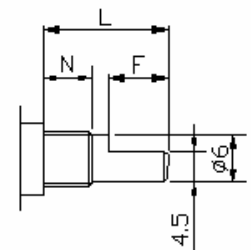

N:6.2m/m

SHAFT-TYPE	L	10	15	20	25	30	35	40
KC	A	2.2	6	10	12	12	12	12
	C	0.5	1	2	2	4	4	4
F	F	2.5	7	12	12	12	12	12
R,RE	L	10	15	20	25	30	35	40

**12mm Metal Shaft Rotary Potentiometer (4 Ganged) – With Switch****Electrical Characteristics**

<b>Total Resistance</b>	1K ~ 500K $\Omega$				
<b>Total Resistance Tolerance</b>	$\pm 20\%$ (More than 1M $\Omega$ $\pm 30\%$ )				
<b>Resistance Taper</b>	A. B. C. D. W. Taper				
<b>Resistance Taper Characteristics</b>	A50%	B50%	C50%	D50%	W50%
	15-25%	40-60%	75-85%	2-15%	45-55%
<b>Rated Power</b>	B Taper : 0.1 W; Other Taper : 0.05 W				
<b>Residual Resistance</b>	$R \geq 250K\Omega$ 0.1%				
	$250K\Omega > R > 10K\Omega$		20 $\Omega$ max. (between Term. 1, 2)		
	$10K\Omega \geq R$		20 $\Omega$ max. (between Term. 2, 3)		
<b>Max. Operation Voltage</b>	AC 30V , DC				
<b>Noise</b>	47 mV Max.				
<b>Insulation Resistance</b>	DC 250V 100M $\Omega$				
<b>Withstand Voltage</b>	1 minute at AC 300V				
<b>Rotational Life</b>	15,000 Cycles				

**Mechanical Characteristics**

<b>Total Rotational Angle</b>	300° $\pm$ 10°
<b>Stopper Strength</b>	3 kgf.cm max./3sec.
<b>Rotational Torque</b>	20~200gf.cm
<b>Pull-Push Strength</b>	8 kgf.cm max./ 10sec.
<b>Soldering Heat</b>	300°C , 3s. (Only for Hand-Soldering)
<b>Remark</b>	Shaft: Cast Iron or Aluminum Zinc Bushing Material: Cast Iron or Aluminum Zinc